

LNW	MCF	RMG
1	9	9
2	9	9
3	9	9
4	9	9
5	9	9
6	9	9
7	9	9
8	9	9
9	9	9

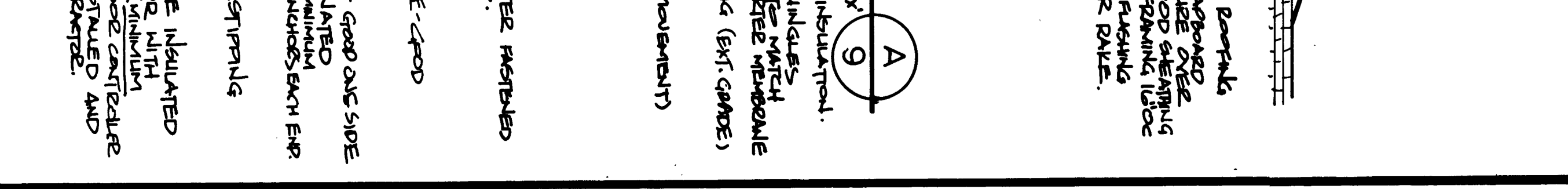
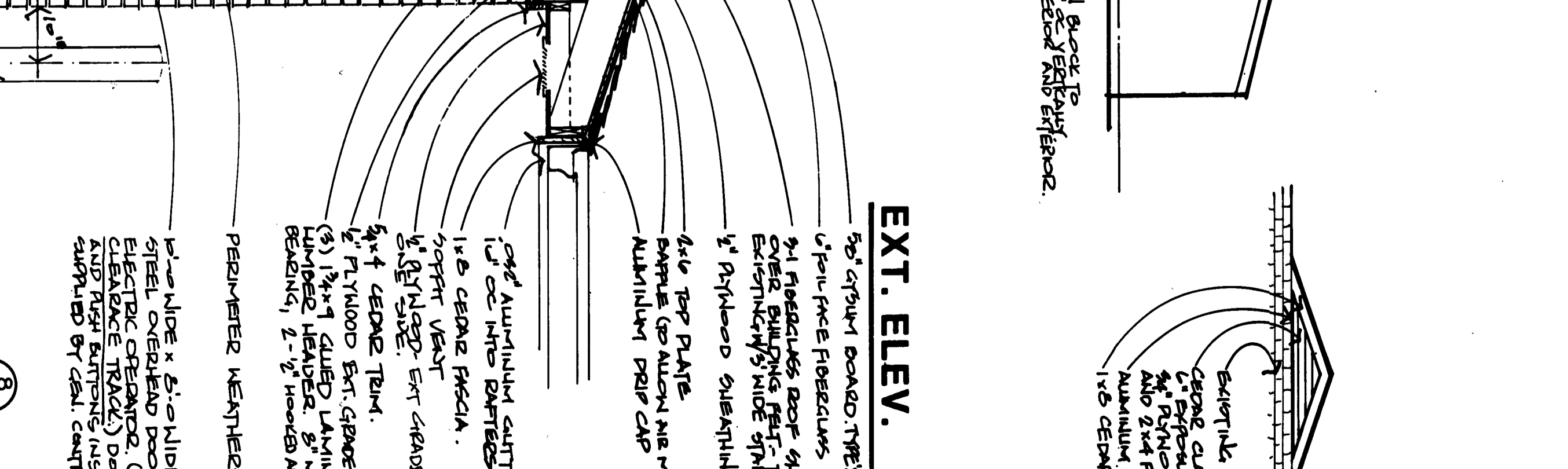
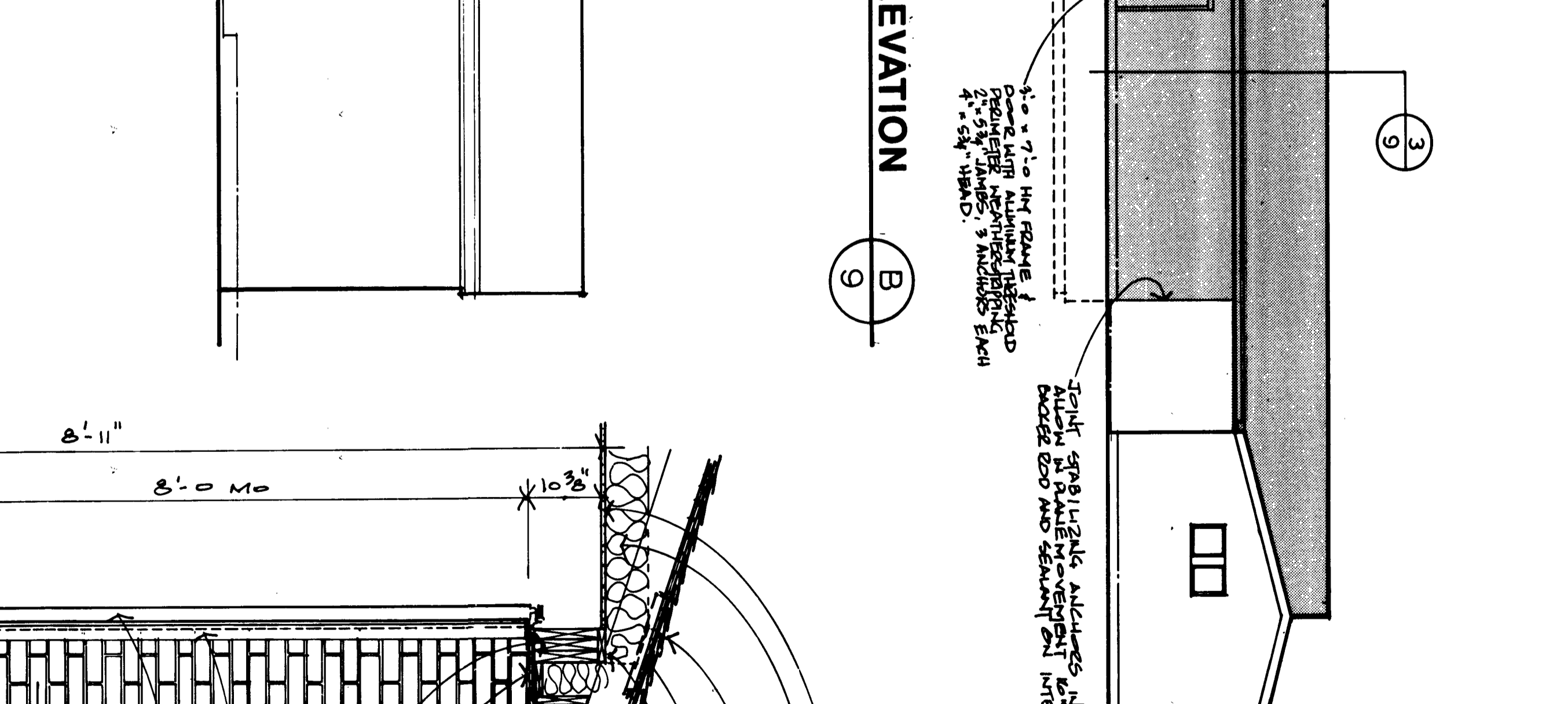
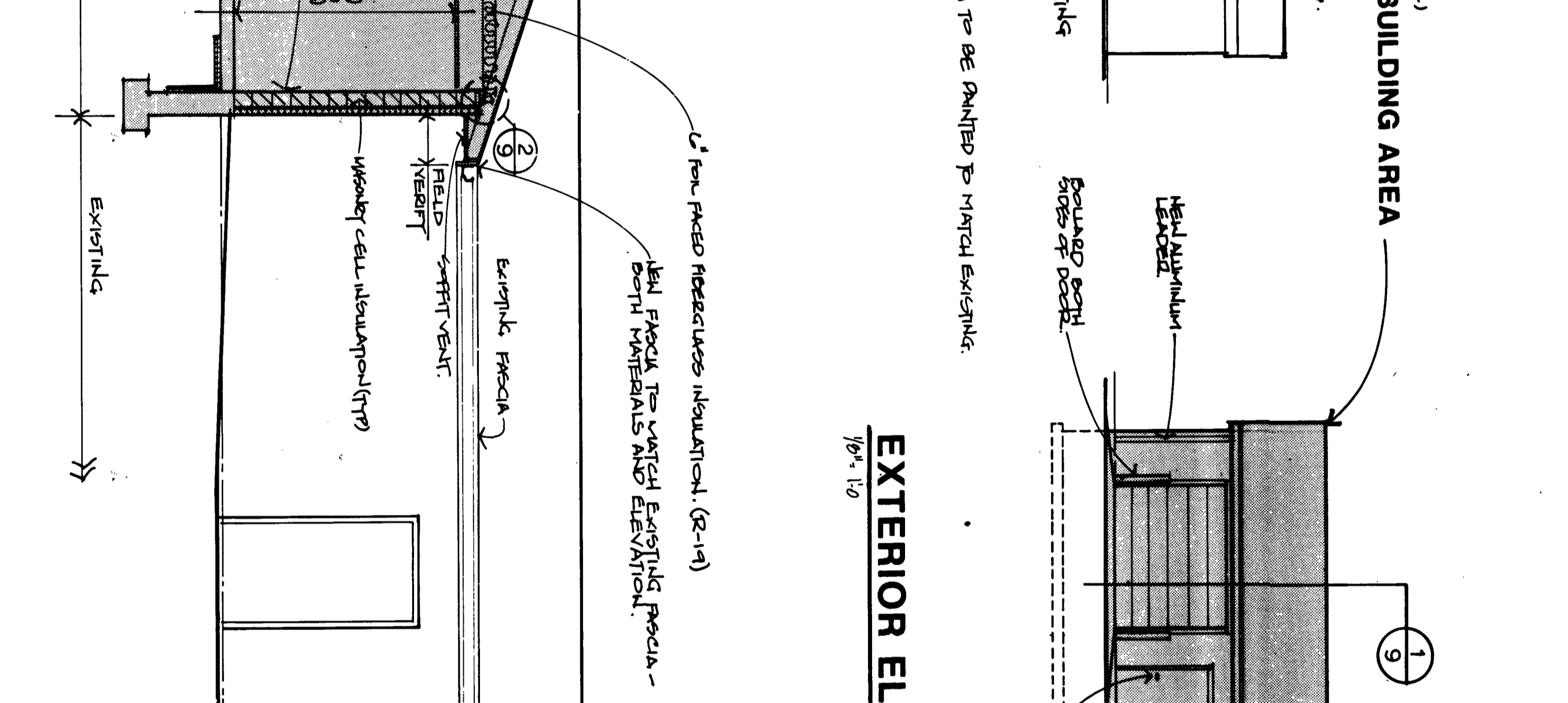
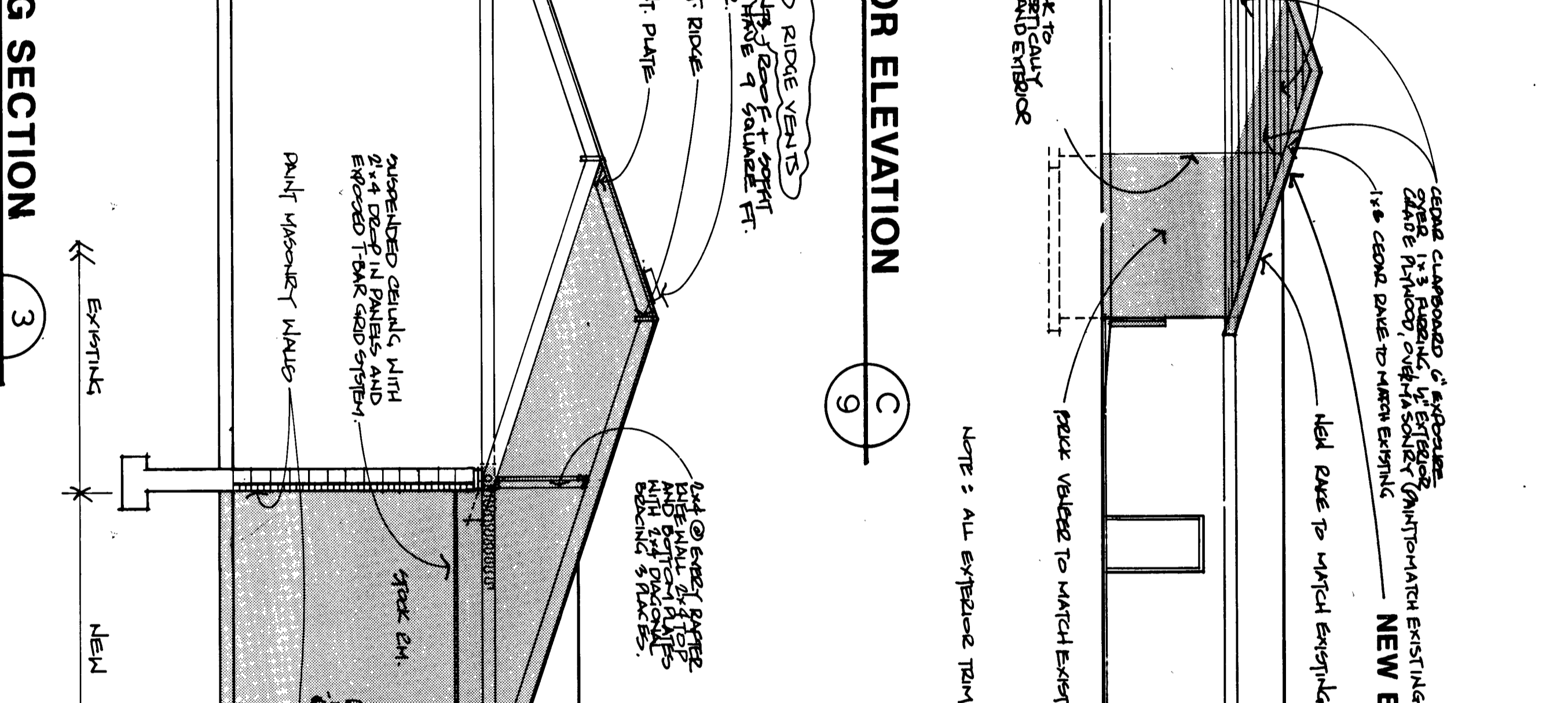
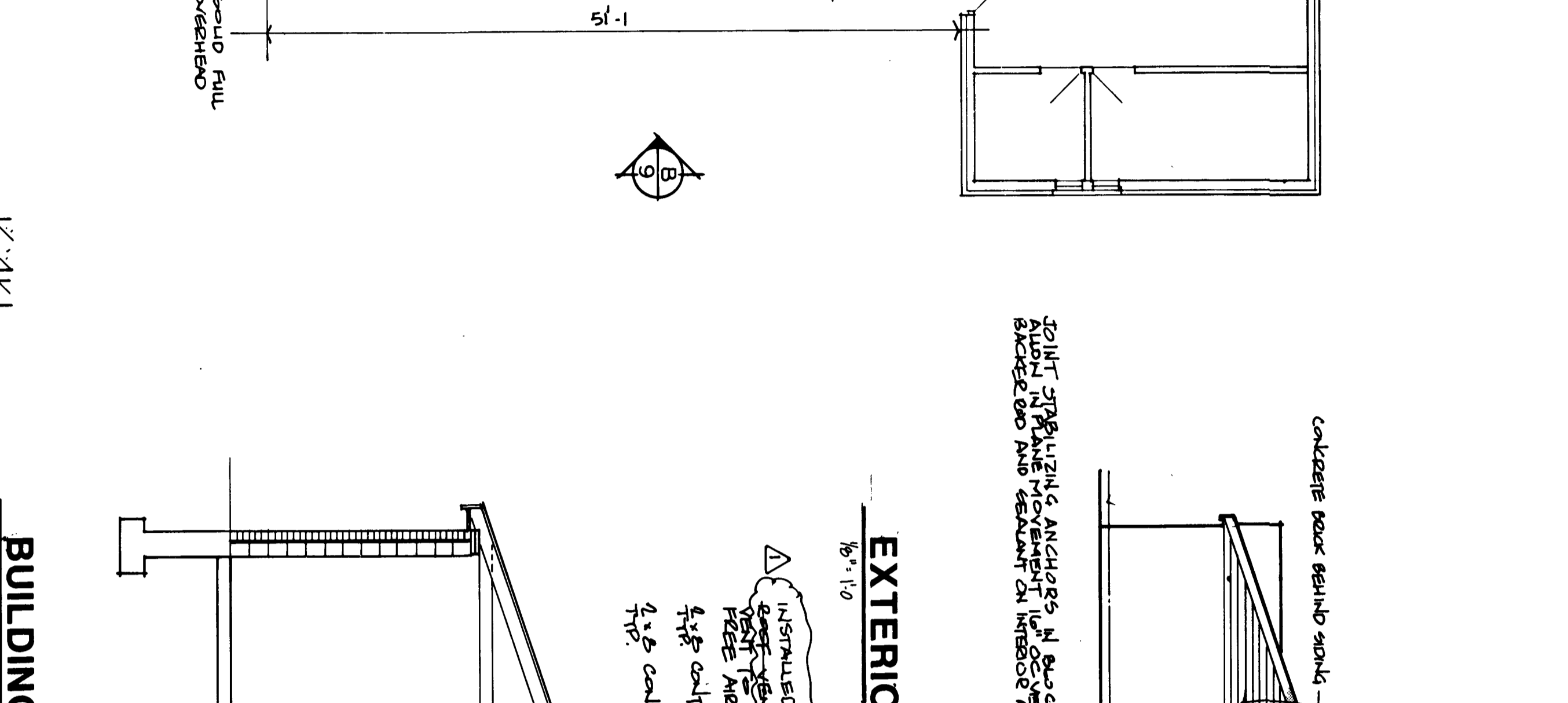
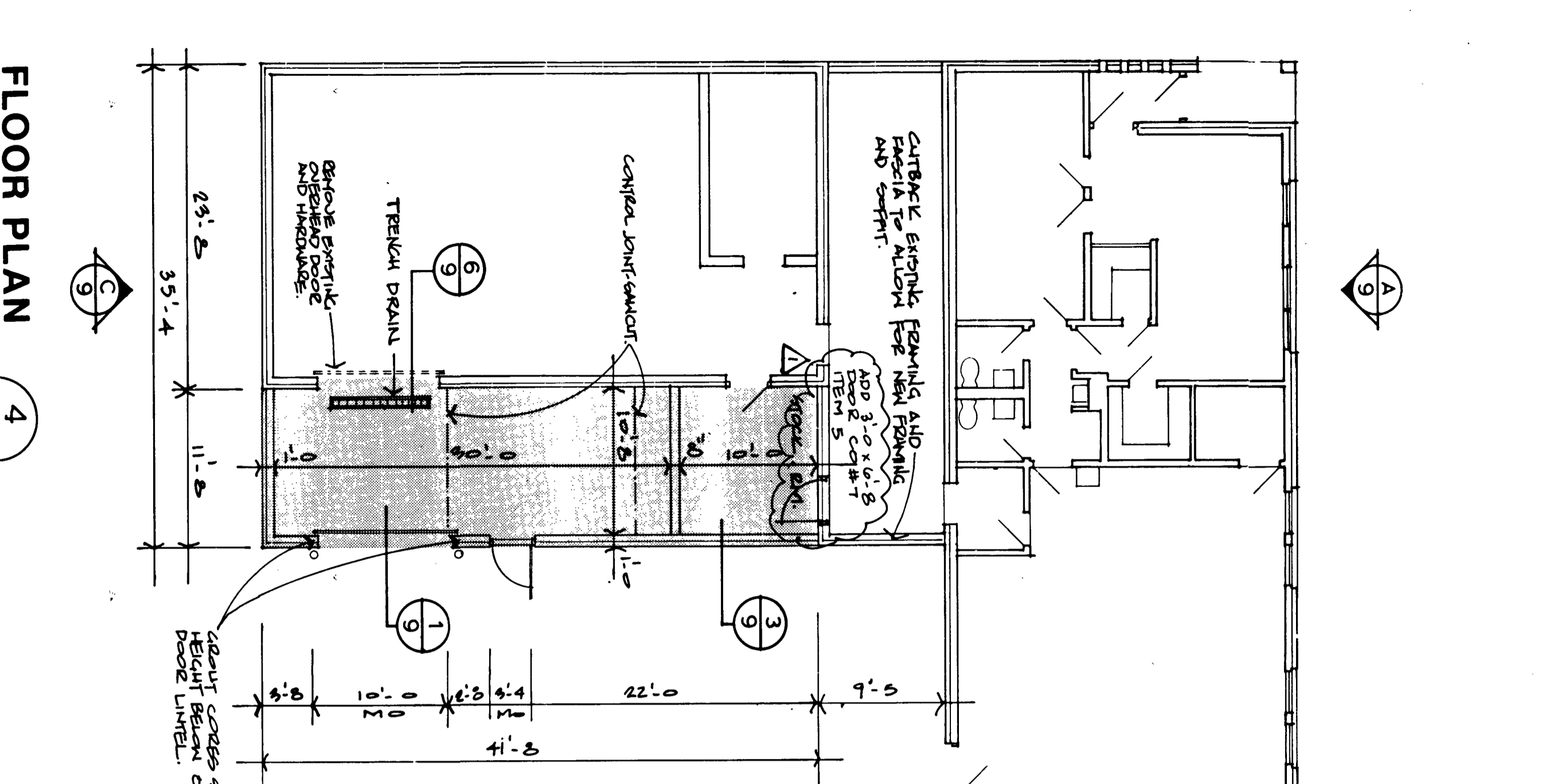
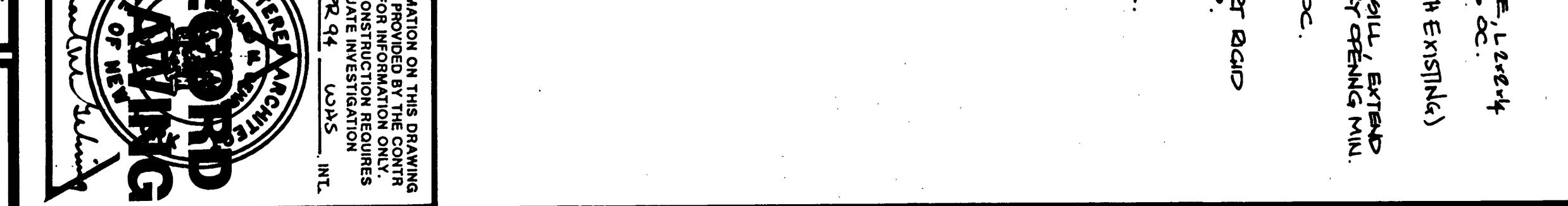
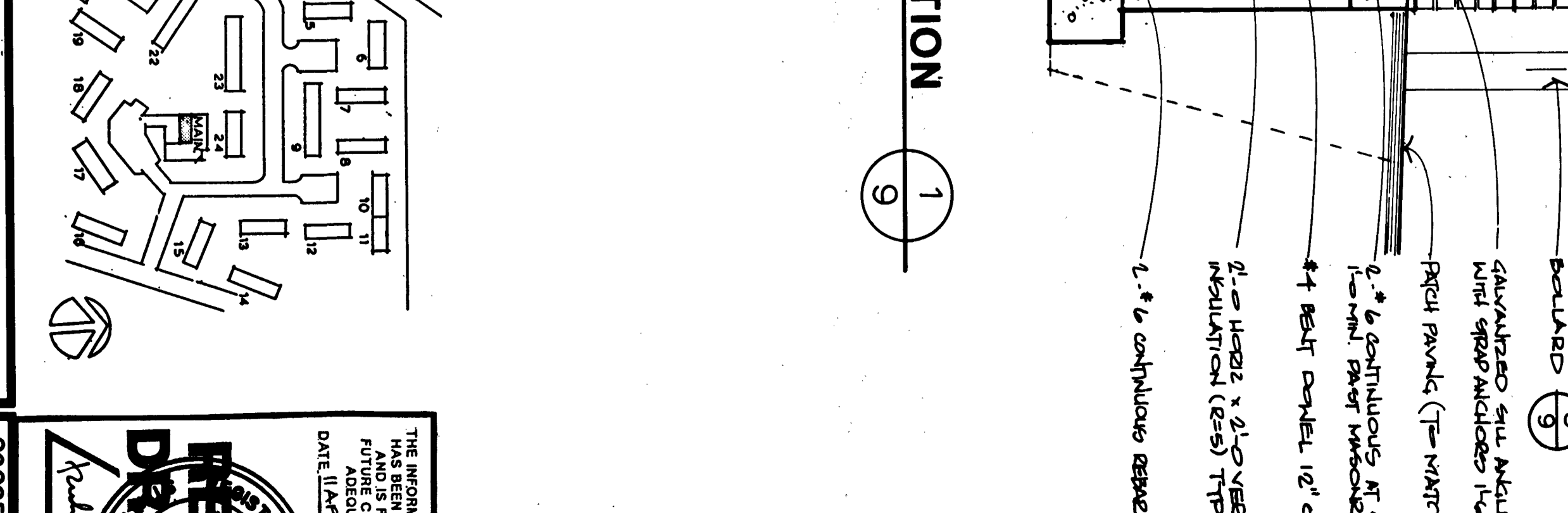
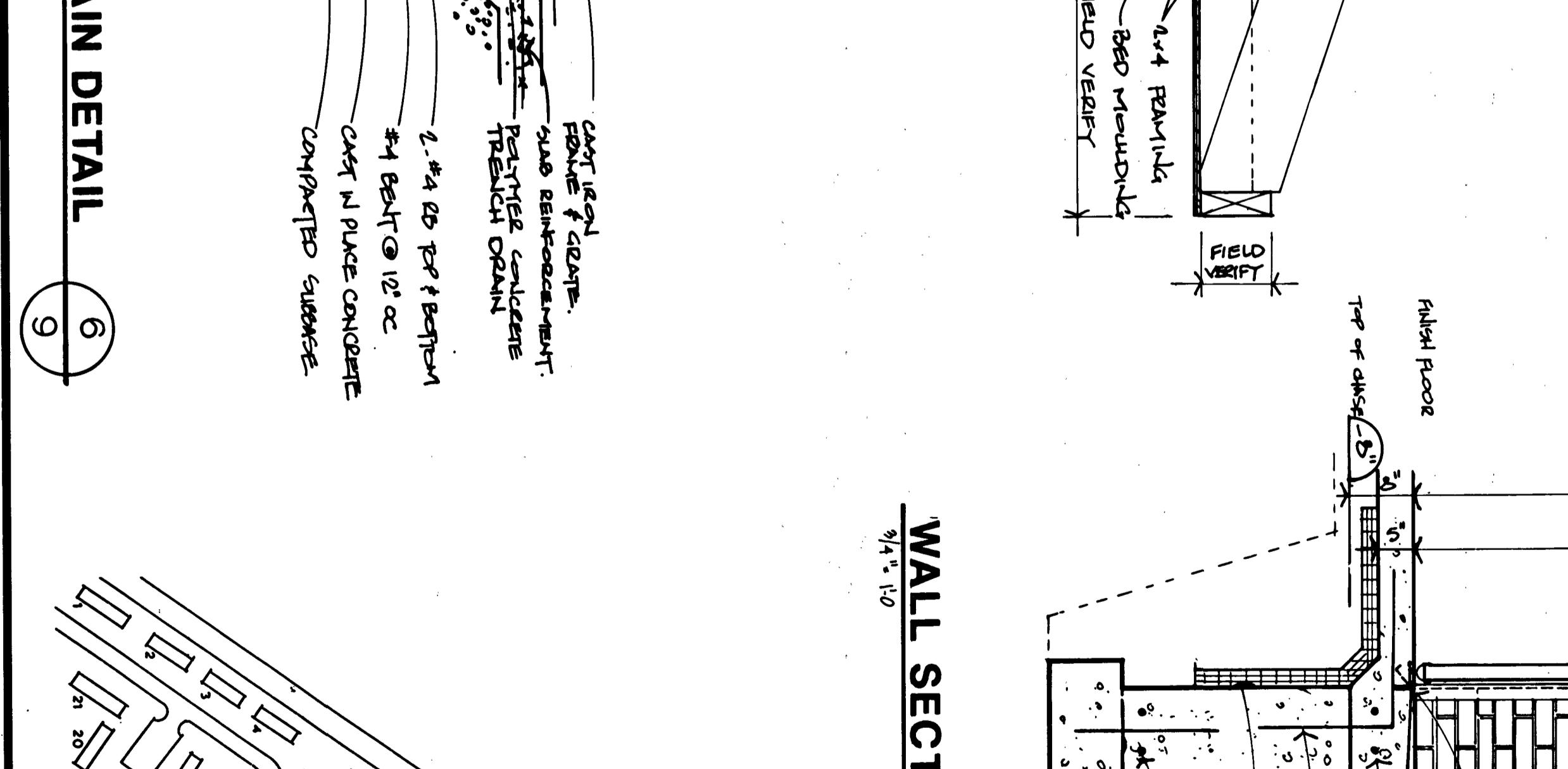
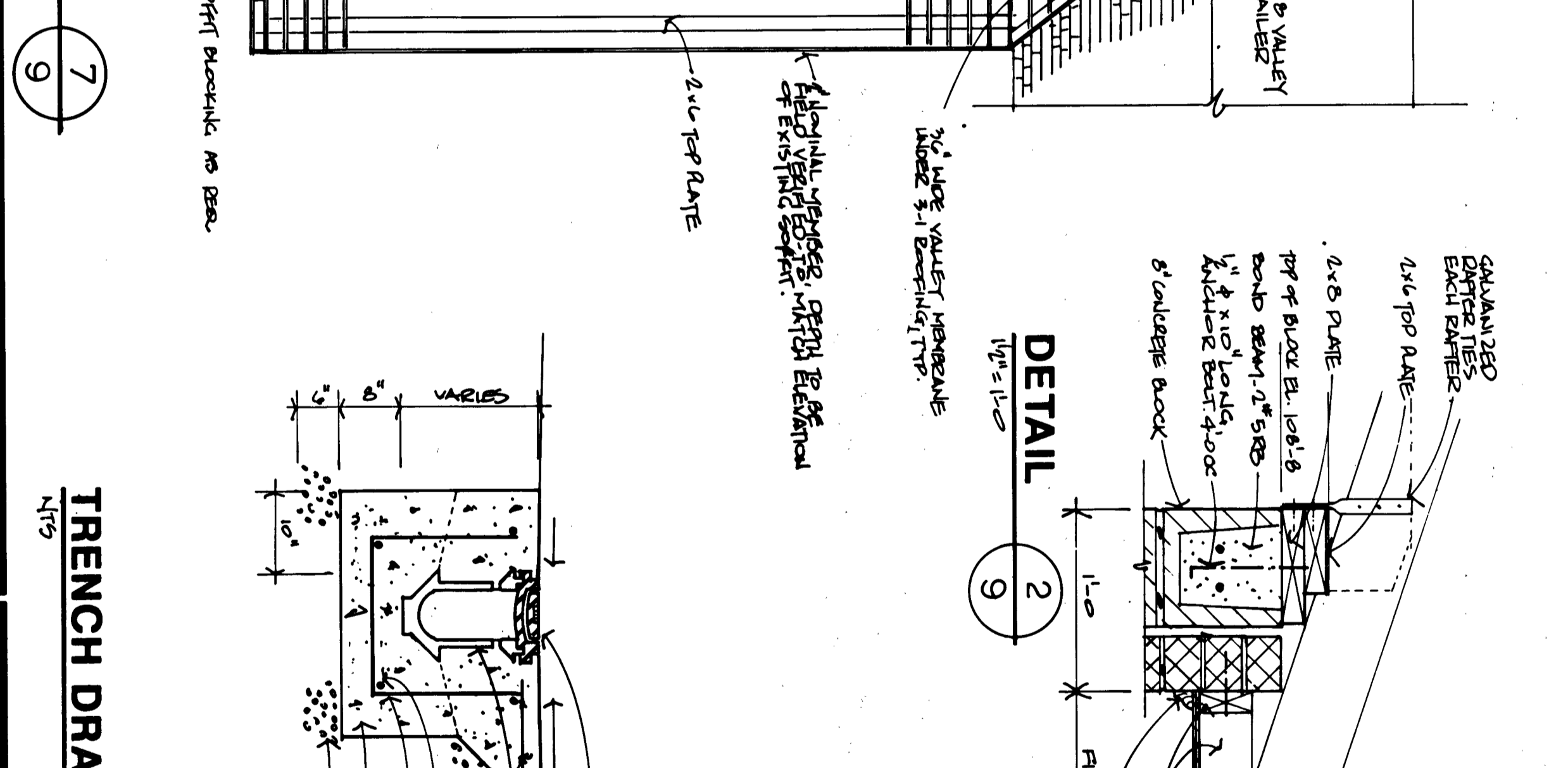
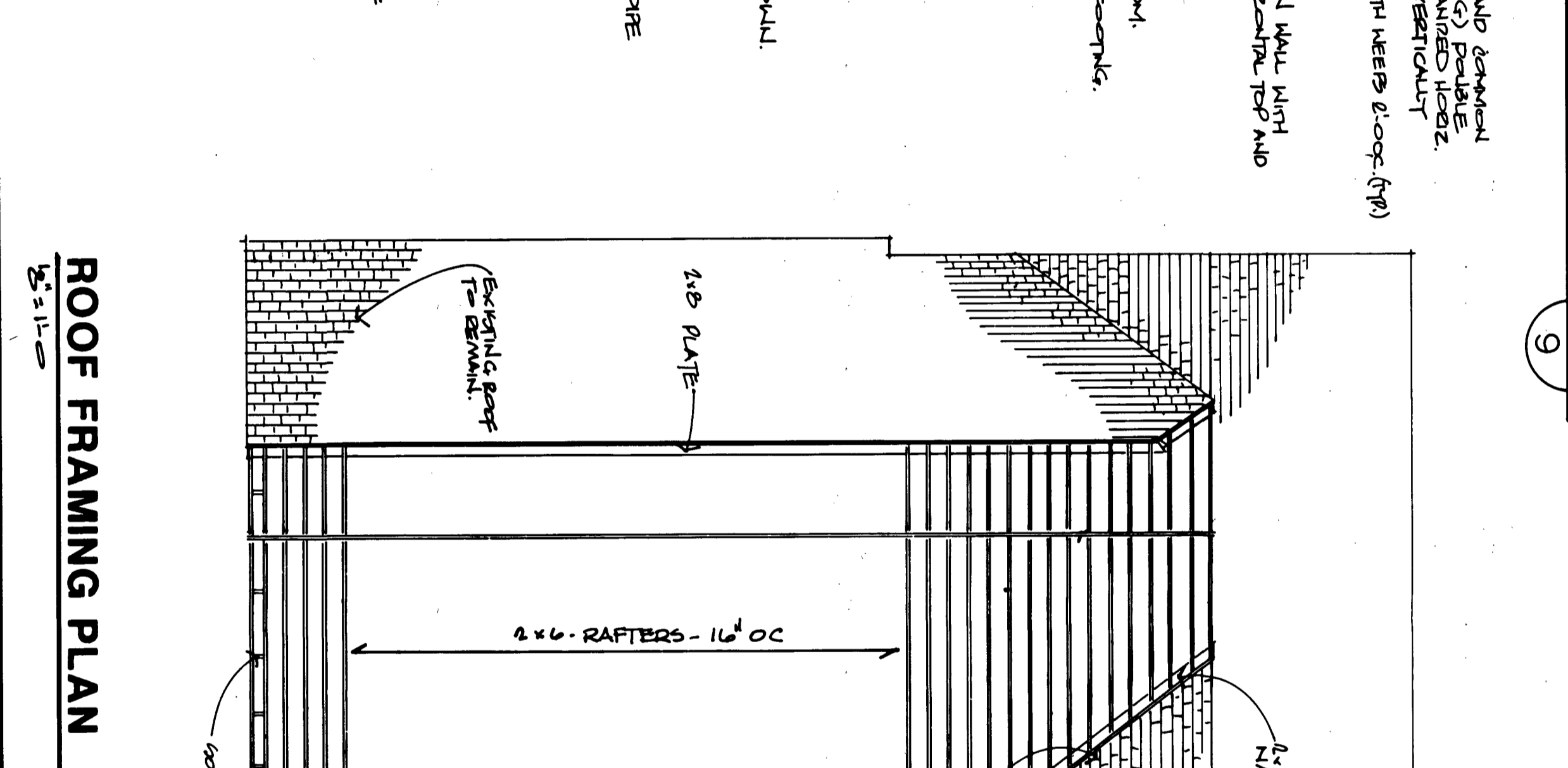
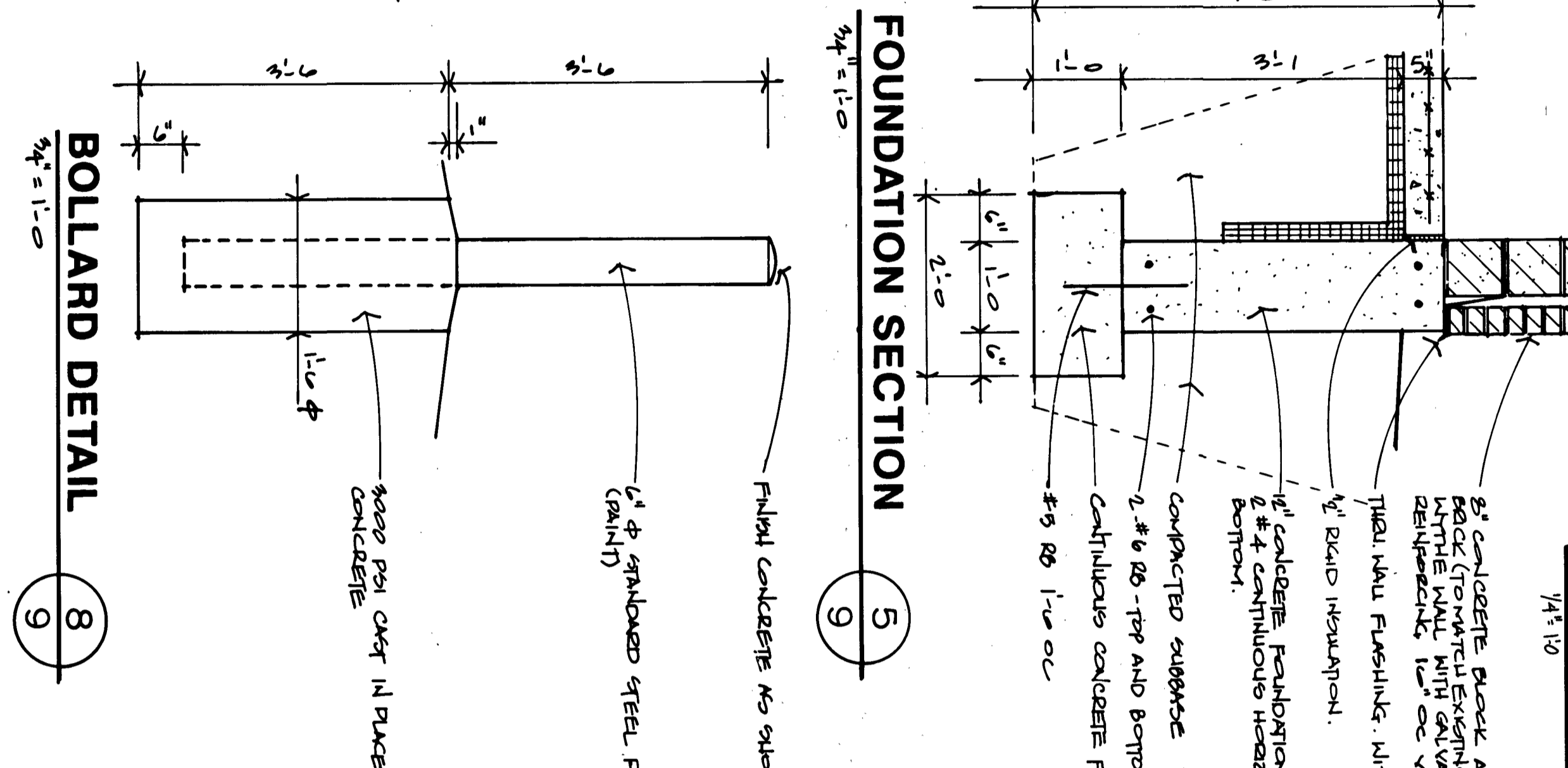
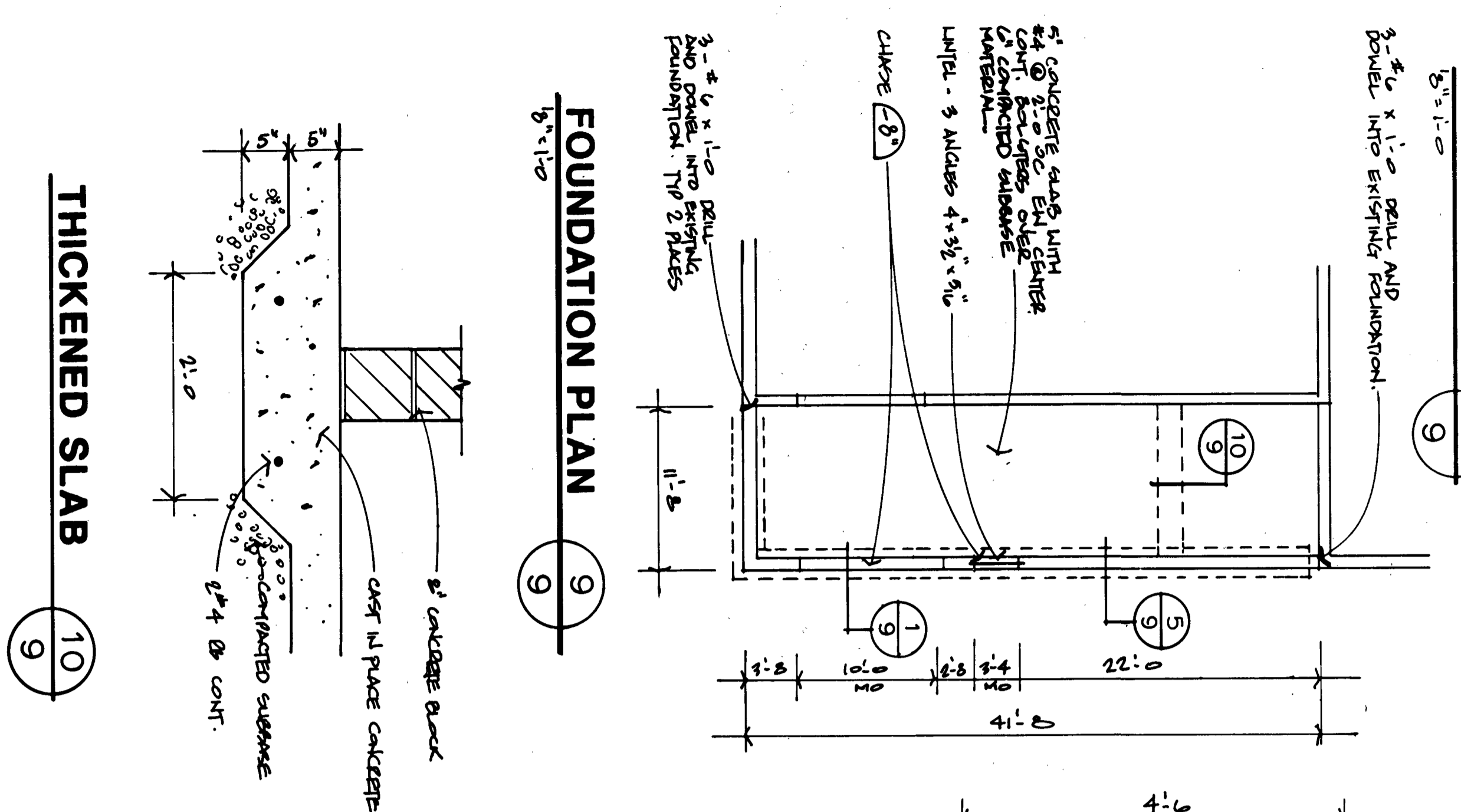

THE INFORMATION ON THIS DRAWING IS THE PROPERTY OF TRAUTMAN ASSOCIATES, INC. AND IS FOR INFORMATION ONLY. IT IS NOT TO BE USED FOR CONSTRUCTION WITHOUT THE WRITTEN PERMISSION OF TRAUTMAN ASSOCIATES, INC. DATE: 11/29/92

TRAUTMAN ASSOCIATES, INC.
225 FRENCH STREET, BUFFALO, NY 14202 (716) 885-4400